

GENERAL INFORMATION

Project Name: _____
Item: _____
Quantity: _____
Model: DECO-103-N
Length: _____

STANDARD NSF LISTED FINISH OPTIONS

- | | |
|---|--|
| <input type="checkbox"/> Stainless Steel #4 | <input type="checkbox"/> Chrome |
| <input type="checkbox"/> Gloss Black | <input type="checkbox"/> Wrinkle Black |
| <input type="checkbox"/> Smoked Copper | <input type="checkbox"/> Polished Brass Finish |
| <input type="checkbox"/> Other _____ | |

TUBE OPTIONS

- | | |
|--|--|
| <input type="checkbox"/> 1-1/2" Round (standard) | <input type="checkbox"/> 1" Round Diameter |
| <input type="checkbox"/> 1" Square | <input type="checkbox"/> 1-1/2" Square |

GLASS THICKNESS

- | |
|---|
| <input type="checkbox"/> 1/4" Tempered Glass (not for shelves)
Centerline Max 54" |
| <input type="checkbox"/> 3/8" Tempered Glass (standard) (for shelf or span more than 54")
Centerline Max 66" |
| <input type="checkbox"/> 1/2" Tempered Glass (for shelf or span more than 66")
Centerline Max 72" |

GLASS PANEL OPTIONS

- Full Perimeter Channel

INSTALLATION OPTIONS

- | | | |
|--|--|---------------------------------------|
| <input type="checkbox"/> Above-Counter: Round Tube | <input type="checkbox"/> Narrow Flange | <input type="checkbox"/> Round Flange |
| <input type="checkbox"/> Above-Counter: Square Tube | | |
| <input type="checkbox"/> Under-Counter: Round Tube | | |
| <input type="checkbox"/> Under-Counter: Square Tube | | |

See Installation Page for More Information.

DECO-103-N

Vertical Operator-Serve Food Shield

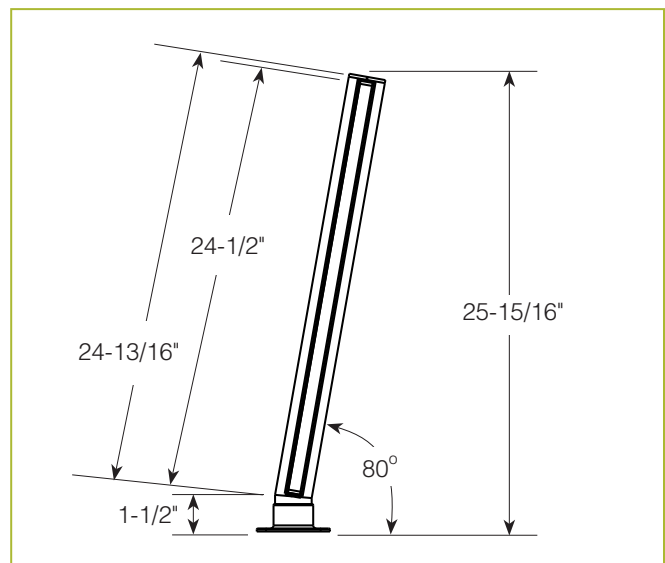

To meet NSF guidelines, end panels are included on all BSI quotations unless specifically excluded.

Glass Shipped Separately from Posts

* Approval Drawings Required